

Technical specification

Genier GO! 80 FS Mixer kettle

Net volumes:

- Net / Gross: 80 / 90 liters

Heating:

- Electric
- Steam

Installation:

- Freestanding

Mixer:

- Mixing speed 10 - 160
- 7 mixing modes, inc. auto-reverse
- Lid-open-mix when lid opened or kettle tilted
- Three-piece mixer tool with removable scrapers

Construction:

- Electronic tilting with adjustable tilt-back function
- 600mm tilting height
- Jacket max. pressure 1.5 bar [128 °C]
- Kettle interior AISI 316 stainless steel, outer body AISI304L
- Removable stainless steel lid that can be rotated 360 degree in place
- Spring-loaded lid hinge
- Lid has a large grid openings with a separate lid for the grid

Control system

- 10" touch screen controller
- Set value for temperature 0...125 °C
- Temperature indication with 1 °C resolution
- Automatic temperature control based on jacket temperature
- Automatic food water
- Cooking programs memory
- Timed start for cooking programs
- Maintenance counters and helpers
- Service diagnostic for troubleshooting

Optional functions

- Automatic temperature control based on food temperature
- Automatic water supply with measurement
- HACCP reports memory



- Foot-pedal that enables e.g. lid-open-mixing
- Washing hose and storage compartment
- Enhanced mixing power
- Pt100 connection to external HACCP system
- Energy optimisation connection
- Hot cooking water connection and switch
- Soft water connection
- Cooling with mains water
- Emptying valve
- Floor-mounted installation

Accessories

- Measurement stick
- Strainer plate
- Washing tools
- Whipping tool
- Mixing hook
- Folding tool
- Wall holder for kettle tools
- Trolley for kettle accessories
- GN-tray holder
- Trolley for GN-tray

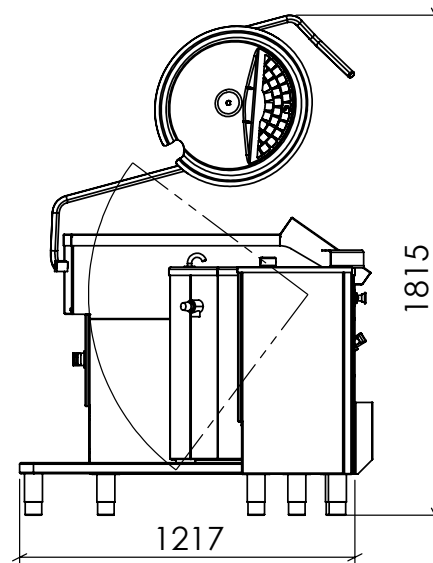
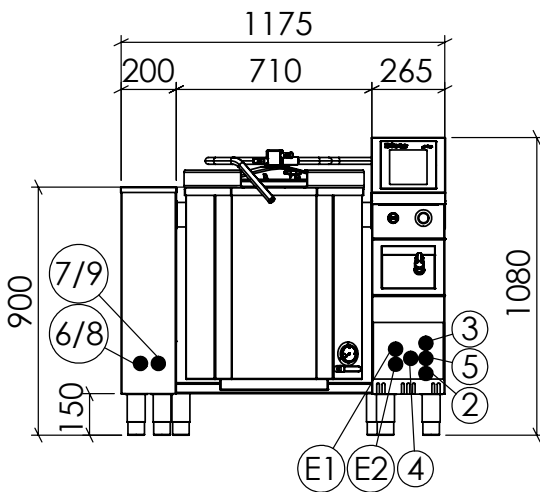
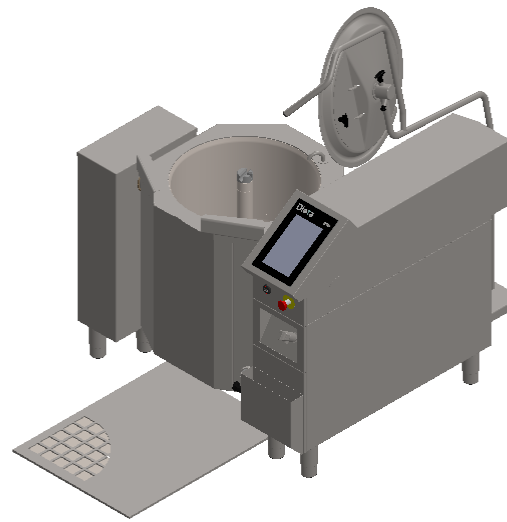
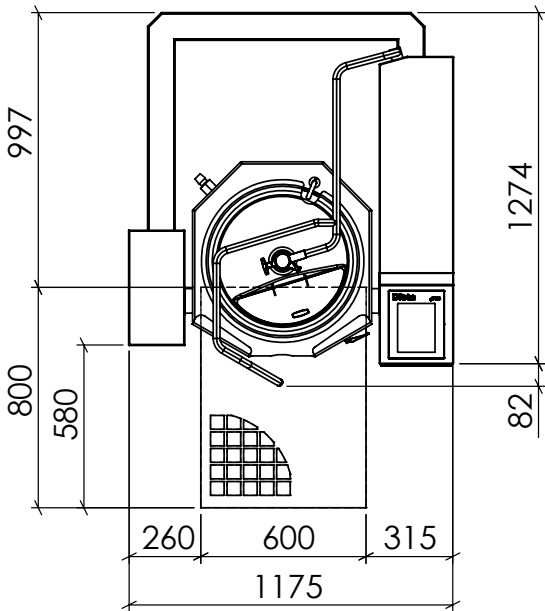

Technical information - Genier GO! 80 FS

- Volume, net/gross: 80 / 90 liters
- Weight, net/with transport package: 245 / 325 kg
- Tilting height: 600 mm
- Connections (flexible):
- Electric (Electric model) #E1 22,5 kW, 400V 3~, 40A, 50/60 Hz
- Electric (Steam model) #E2 1 kW, 230V 1~, 16A, 50/60 Hz
- Cold water #2 DN 15, G1/2", 200...600 kPa [2...6 bar], Filtered to 15 µm *
- Warm water (Option) #3 DN 15, G1/2", max 60 °C, 200...600 kPa [2...6 bar]
- Hot water (Option) #4 DN 15, G1/2", max 80 °C, 200...600 kPa [2...6 bar], Filtered to 15 µm *
- Softened water (Option) #5 DN 15, G1/2", 100...600 kPa [1...6 bar], Filtered to 15 µm *
- House steam (Steam model) #6 DN 15, G1/2", 150...200 kPa [1,5...2 bar], 35 kg/h
- Condensate (Steam model) #7 DN 15, G1/2", Counter pressure 0 kPa [0 bar], downward line

* Water for kettle jacket:

Filtered to 15 µm, 0...40 °C, max 5 °dH, conductivity 30... 1000 µS/cm, chloride max 100 mg/l, chlorine max 0,25 mg/l, pH 6,5...9,5

Genier GO! - Technical descriptions

INSTALLATION

- Free Standing Installation .
- Without the need for floor bolting. Making the kettle easy and inexpensive to install, and easy to move as needed.
- No need to pierce the waterproofing of the floor.

HEATING

- Electric model.
- Steam model.

CONTROLLER

- Large and easy-to-read 10-inch touch screen with clear and far-sighted information
- Electronic control for heating, water filling, and mixing.
- Large and easy-to-use control buttons for adjusting kettle functionalities. Only available functions are active.
- The touch screen can be locked during washing to avoid incorrect presses.
- An unactive touch screen can be placed in an energy-saving sleep mode, from where it returns to immediate use.

HEATING

- The heating is controlled based on the jacket temperature
- Temperature display with 1 °C resolution with clear numerical display. Adjustment range 0... 125 °C.
- The maximum pressure of the jacket is 1.5 bar.

MIXER

- Two-way rotary bottom mixer integrated into the bottom of the kettle, free to use in all positions.
- The mixing tool can be disassembled into three (3) separate parts weighing up to 3 kg. Enabling ergonomic handling of the tool when placing in and removing from the kettle.
- Mixing tool that can be disassembled and washed completely in a 500x500mm washing basket at a washing machine.
- The mixing tool is well suited for e.g. cold preparation, crushing, pureeing (eg mashed potatoes), mixing of mixes, kneading and whipping.
- Parts of the mixing tool can be replaced with special tools according to the prepared product's requirement.
- Stepless mixing speed selection between 10-160 [10-160 rpm]
- Seven (7) ready-made mixing programs are suitable for versatile food production. Mixing programs as needed can be self-modified.
- The mixer stops automatically if the kettle lid is opened.
- The mixer can be activated with a pulse switch when the lid is open, the kettle is tilted or the kettle is tilting.

FOOD WATER FILLING

- Automatic water filling is based on the selected liters of water or the amount of water added is measured.
- The water spout is located on the edge of the pot. It can be used with the lid closed and the kettle tilted.

TILTING

- Electric tilt.
- An adjustable tilt-back function that automatically stops the product from emptying from the kettle when tilting stops.
- When emptying, the kettle tilts from the height of 600 mm, which allows ergonomic working height and emptying even in large containers.

LID

- The lid is a durable stainless steel lid that is equipped with a spring-loaded hinge.
- The lid has a large safety grid [incl. separate lid] for adding ingredients.

- The lid is removable for transfer to the wash.
- The kettle lid can be rotated 360 degrees in place, allowing the lid to be wiped without reaching over the kettle.

CONSTRUCTION

- The top rim of the kettle is separated from the heating area so that the top of the rim does not become hot during cooking.
- Volume markings on the inner surface of the kettle.
- Kettle inner parts in contact with food made of AISI 316 acid-proof stainless steel.
- Kettle covers, stand, and other parts are AISI 304 stainless steel.

PROGRAMS

- User-programmable cooking processes,
- Two step programs with settings for cooking/chilling temperature and time, and mixing.
- The user can schedule their own cooking programs to start automatically

WASHING PROGRAMS

- Ready-made washing programs
- The washing attachments tools, which can be replaced, enables automatic cleaning of the inner surfaces of the kettle.
- Washing programs heat and dispense the wash water and start the washing tool.
- Wash complete notification with a summary of the energy and water consumption of the washing program.

USERS AND SETTINGS

- Service mode with service diagnostics and actuator tests directly from the controller display
- The user can customize the basic settings to suit his own needs.

SAFETY FUNCTIONS

- The pressure switch stops heating if the pressure in the steam jacket rises too high.
- The safety valve opens if the pressure in the kettle rises above the permissible level.
- The float switch prevents heating if there is too little water in the steam generator.
- A note text on display indicates the need for power separation.
- The tilt motor overcurrent limit prevents the motor from breaking.
- The tilt motor is equipped with a mechanical brake that prevents unintentional movement.
- The overcurrent and overheating limits of the mixing motor protect the motor.

COMPLIANCE

- The kettle fulfills DIN18855-1 standard for Rapid Kettle
- Compliant to CE requirements for safety
- Prevention of water pollution by backflow in accordance with EN 1717
- Manufactured in ISO 9001 certified factory.

FACTORY INSTALLED OPTIONS

- The heating controlled by automatic temperature control based on the food temperature. Including intelligent heating control to prevent burnout and reduce energy consumption.
- Automatic water filling based on the desired number of liters or measurement of the amount of water added.
- Foot pedal for hands-free control of safety mixing, tilting and water addition.
- Wash hose with pistol and storage case
- Extra Pt100 sensor for food temperature that can be connected to an external temperature monitoring system

- HACCP reports from the cooking programs are stored in the kettle memory and can be transferred with a USB stick.
- Chilling performed with tap water (food water) which flows to drain: (CH3)
 - Activated from control panel or as a part of a program
 - Chilling temperature can be set. Chill-Hold function is activated if a chill temperature is set
 - Chill media is tap water which is led continuously to drain
 - At end of the chilling process the jacket is emptied automatically (to drain)
- Microfilter to be installed in the inlet water connection, replaceable filter cartridges.
- Emptying pipe, 2 ", for the front of the kettle. Echtermann valve by default
- Emptying pipe, 2.5 ", for the front of the kettle.
- Emptying pipe, 2.5 ", at kettle bottom with clamp connection to the user's own valve
- Active central axis that provides additional heating or chilling surface.
- Floor-mounted installation with the feet bolted to the floor
- Subsurface installation frame for floor-mounted installation

ACCESSORIES

- Measurement stick
- Strainer plate
- Washing tools
- Whipping tool
- Mixing hook
- Folding tool
- Wall holder for kettle tools
- Trolley for kettle accessories
- GN-tray holder
- Trolley for GN-tray