

Kettle Celer 80

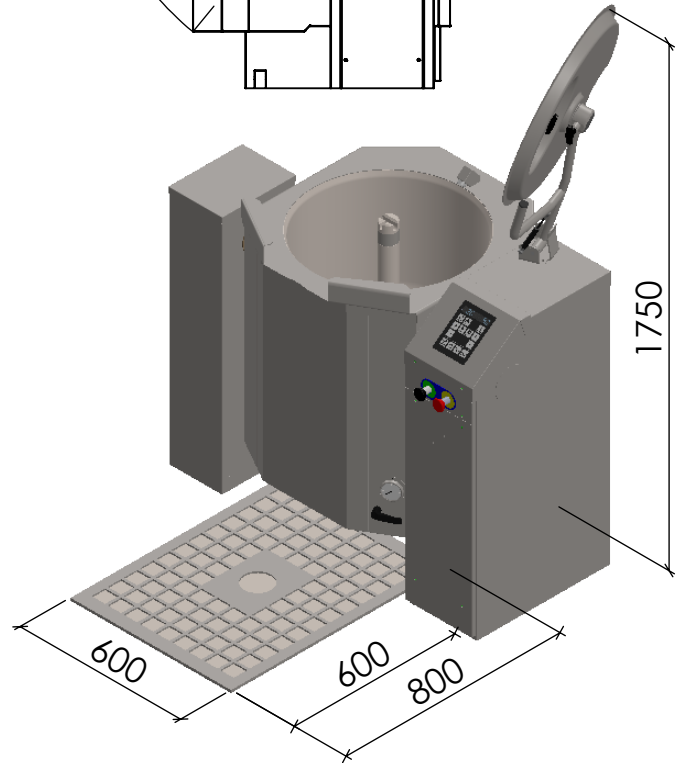
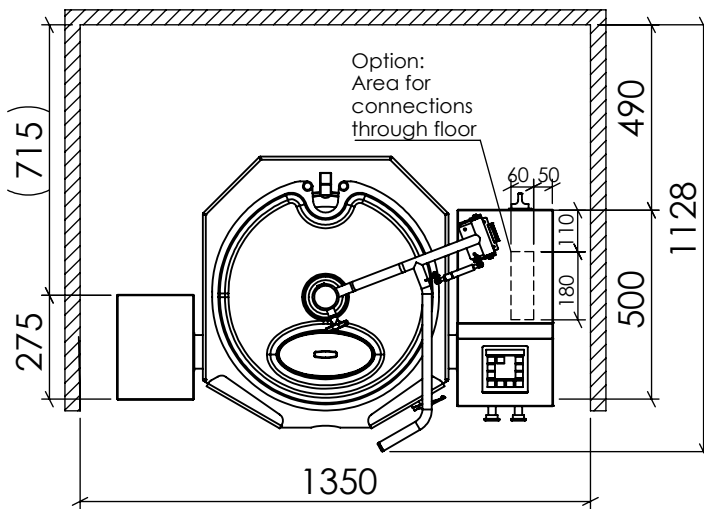
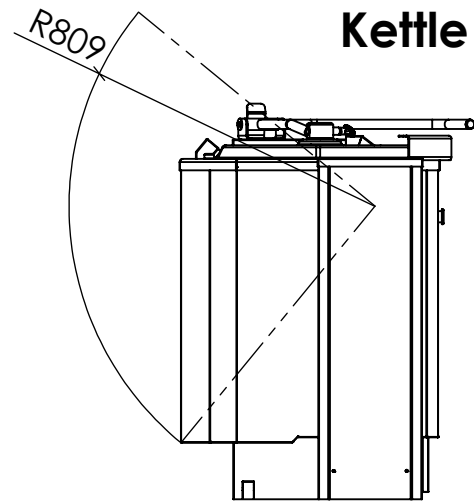
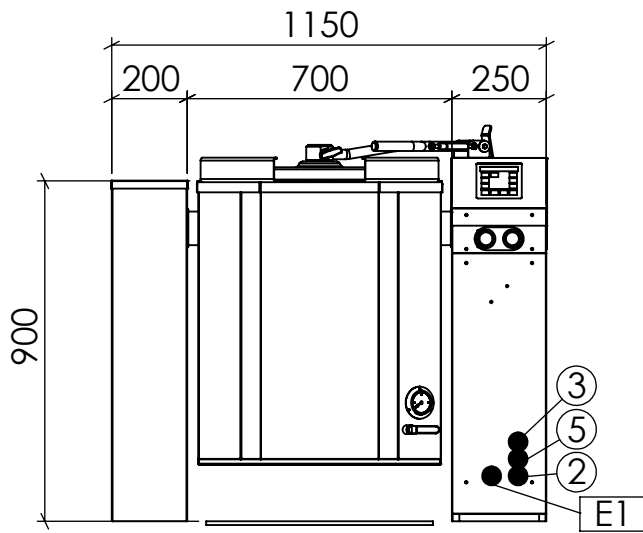

Technical information

- Tilting height 575 mm
- Volume net/gross 80 liters / 90 liters
- Weight 160 kg
- Transport package (WxDxH) 1340 x 985 x 1330 mm / 220 kg

Connections (Flexible):

- Electric (Electric model) #E1 14,5kW, 400V, 3~, 32A, 50/60 Hz
- Cold water #2 DN 15, G1/2", 2...8 bar, Filtered to 15 µm, *
- Warm water (Option) #3 DN 15, G1/2", 2...8 bar
- Soft water (Option) #5 DN 15, G1/2", 1...8 bar, Filtered to 15 µm, *

* Water for steam generator: 0...40°C, max 6°dH, conductivity 30...1000 µS/cm, chloride <100 mg/l, chlorine <0,25 mg/l, pH 6,5...9,5

Options (factory installation required):

Wash hose with spray pistol • Single hand faucet Cold/Warm for spray pistol • Food temperature measurement for external HACCP-system • Chill CH1 • Connections through floor

Accessories:

- Strainer plate • Washing tool • Mixing hook • Whipping tool • Container support • Tool trolley
- Wall bracket for mixing tools

